

KI3212

## Grande shopper "evergreen"

- Grande capacità con fondo piatto e soffietto.
- Manici robusti in cotone in tinta con la borsa.
- Esclusivo effetto slavato Vintage look con variazioni di colore.

100% cotone. Grande borsa rettangolare con fondo piatto e ampio soffietto. Manici nello stesso materiale della borsa. Ampia capacità interna. I prodotti sbiaditi sono unici e potrebbero presentare leggere variazioni di colore.

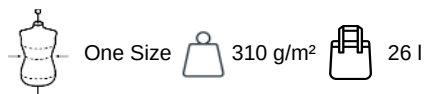

### Certificazioni

### Informazioni complementari

#### Logistica



#### Paese d'origine



#### Codice doganale

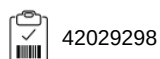

Dimensioni

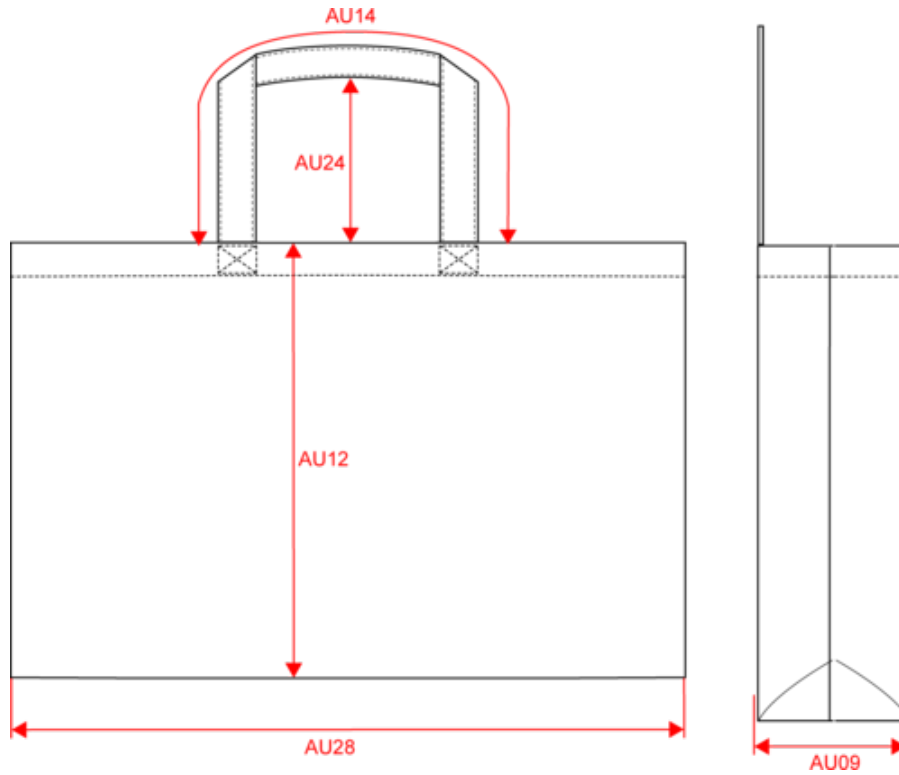





Measurements in cm	One Size
AU09 - Depth of bottom part	14.00
AU12 - Total height	37.00
AU14 - Handle length	70.00
AU24 - Handle height	30.00
AU28 - Bottom width	49.00



KI3212

## Grande shopper "evergreen"

### Informazioni colori

 <b>Washed Black</b> RVB : 43,39,42 Pantone C : Neutral Black Pantone TCX : 19-4008TCX	 <b>Washed Dream Blue</b> RVB : 143,175,196 Pantone C : 2156C Pantone TCX : 15-4005TCX	 <b>Washed Green Clay</b> RVB : 141,146,132 Pantone C : 4220C Pantone TCX : 17-6206TCX	 <b>Washed Lichen Green</b> RVB : 132,120,84 Pantone C : 7756C Pantone TCX : 17-0627TCX	 <b>Washed Natural</b> RVB : 213,200,178 Pantone C : 480C Pantone TCX : 16-1212TCX
 <b>Washed Navy</b> RVB : 46,54,68 Pantone C : 432C Pantone TCX : 19-4022TCX	 <b>Washed Nude Peach</b> RVB : 213,177,143 Pantone C : 727C Pantone TCX : 14-1122TCX	 <b>Washed Olive Gray</b> RVB : 147,128,94 Pantone C : 872C Pantone TCX : 17-1022TCX	 <b>Washed Pearl Blue</b> RVB : 175,189,196 Pantone C : 5517C Pantone TCX : 14-4206TCX	 <b>Washed Pink Ochre</b> RVB : 160,94,85 Pantone C : 7524C Pantone TCX : 17-1525TCX
 <b>Washed Tawny Orange</b> RVB : 201,106,84 Pantone C : 7619C Pantone TCX : 16-1440TCX				

Logistica  1  40

Sizes	Width (cm)	Height (cm)	Length (cm)	Net weight (kg)	Gross weight (kg)	Pieces/Box	Pieces/Bundle
One Size	42.00	25.00	52.00	9.5	11	40	1