

ARTWORK APPROVAL FORM

ORDER DETAILS

ORDER NUMBER: X
ITEM CODE: ML1010
QUANTITY: X

ITEM DETAILS

FABRIC: POLYESTER
ITEM SIZE: 15 cm x 2 (Ø 0,7 cm)
LABEL: WOVEN ST. SIZE (4 x 2 cm, folded)
FULL COLOUR ST. SIZE (3,8 x 2 cm, folded)

MATERIAL COLOURS

COLOUR 1: X
COLOUR 2: X
BAND: X
BADGE HOLDER (MLAS02 / MLAS03): STANDARD / OWN PMS / NONE
PATCH: X / NONE



SCALE 1:2



LABEL FRONT
WOVEN - TECHNIQUE
ALL OVER - LOGO
SIZE

ATTENTION 1

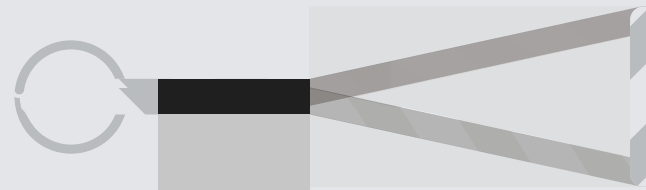

LABEL BACK
WOVEN - TECHNIQUE
ALL OVER - LOGO
SIZE

ATTENTION 1



GENERAL COMMENT:



GENERAL COMMENT:



ATTENTION 1:



ATTENTION 2:

yourChoice

ML1010

SHORT ROUND LANYARD WITH WOVEN LABEL









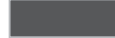

Round 2-tone polyester, with keyring and label.

Size: 15 cm x 2 / Ø 0,7 cm



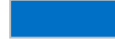









Polyester Patch: Silkscreen (40 x 30 mm)

SCALE 1:1

POLYESTER - STANDARD COLOURS

 WHITE	 COOL GRAY 6 C
 BLACK	 425 C
 REFLEX BLUE C	 348 C
 286 C	 361 C
 281 C	 368 C
 300 C	 YELLOW C
 186 C	 021 C
 485 C	 212 C
 032 C	 260 C







POLYESTER PATCH - STANDARD COLOURS

 WHITE	 PURPLE C
 BLACK	 2036 C
 413 C	 GREEN 0921 C
 1375 C	 2747 C
 207 C	 7690 C
 173 C	 2915 C

BAND - STANDARD COLOUR

 BLACK	 WHITE
--	---

CLIPS - STANDARD COLOUR

 L0 - STANDARD HOOK	 L3 - J-HOOK
 L1 - OVAL HOOK	 L4 - BULLDOG CLIP
 L2 - BLACK OVAL HOOK	 L5 - MOBILE HOLDER
 L8 - STANDARD RING HOOK	

ADDITIONAL ACCESSORIES - STANDARD COLOUR (1:2)

 MLPVBH A	 MLAS02 (STANDARD / OWN PMS)
 MLPVBH B	 MLAS03 (STANDARD / OWN PMS)
 MLPVBH C	 PATCH

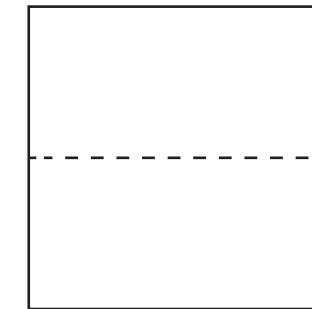

WOVEN LABEL
4 x 4 cm



FULL COLOUR LABEL
3,8 x 4 cm

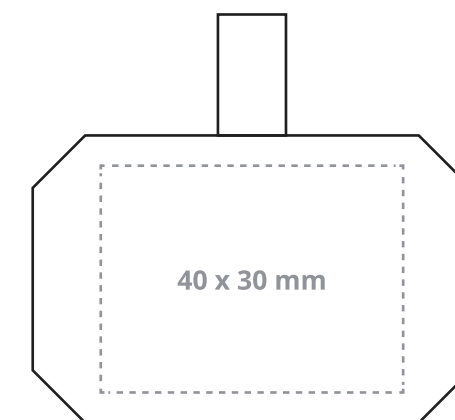

OPTIONAL
PATCH FRONT

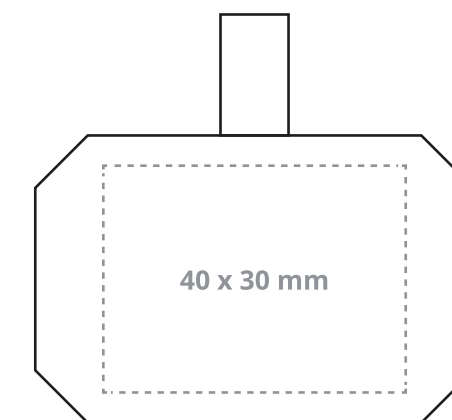

OPTIONAL
PATCH BACK

LEGEND:

----- SAFETY AREA

_____ FINISHED COMPONENT