

ARTWORK APPROVAL FORM

ORDER DETAILS

ORDER NUMBER: X
 ITEM CODE: ML1090
 QUANTITY: X

ITEM DETAILS

MATERIAL: POLYESTER + ZINC ALLOY
 ITEM SIZE: 75 cm x 2 / Ø 0,6 cm
 X: X
 X: X
 X: X

MATERIAL COLOURS

LANYARD: X / OWN PMS X
 KNOT: X / OWN PMS X
 ADJUSTER & HOOK: SHINY SILVER / MATT SILVER / SHINY BLACK / MATT BLACK / MATT OWN PMS X
 PATCH: X / OWN PMS X
 X: X



SCALE 1:4

PATCH FRONT

TECHNIQUE SILKSCREEN
 LOGO -
 SIZE -

ATTENTION 1



ADJUSTER FRONT
 SILKSCREEN -
 TECHNIQUE -
 LOGO -
 SIZE -

ATTENTION 1



PATCH BACK

TECHNIQUE SILKSCREEN
 LOGO -
 SIZE -

ATTENTION 1



ADJUSTER BACK
 SILKSCREEN -
 TECHNIQUE -
 LOGO -
 SIZE -

ATTENTION 1

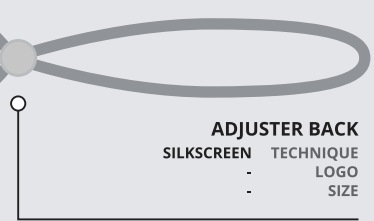

yourChoice



GENERAL COMMENT:



GENERAL COMMENT:



ATTENTION 1:



ATTENTION 2:

ML1090

CROSSBODY CONTRAST KNOT COLOUR PHONE CORD LANYARD

Material: Lanyard - Polyester
Hook - Zinc Alloy
Adjuster - Zinc Alloy





Size: Lanyard length: 75 cm / Ø 0,6 cm
Hook: 12 x 36 mm
Adjuster: Ø 20 mm

SCALE 1:1













Techniques:
Adjuster: Silkscreen / 1-2 colours
Full Color (UV Print)
Engraving
Patch: Silkscreen (40 x 30 mm)

Printing Positions:
Adjuster: no logo
front only
front & back sides (same design)

POLYESTER - STANDARD COLOURS

	WHITE		COOL GRAY 6 C
	BLACK		425 C
	REFLEX BLUE C		348 C
	286 C		361 C
	281 C		368 C
	300 C		YELLOW C
	186 C		021 C
	485 C		212 C
	032 C		260 C

POLYESTER PATCH - STANDARD COLOURS

	WHITE		PURPLE C
	BLACK		2036 C
	413 C		GREEN 0921 C
	1375 C		2747 C
	207 C		7690 C
	173 C		2915 C

METAL ACCESSORIES - STANDARD COLOUR

	SILVER		BLACK
--	--------	---	-------

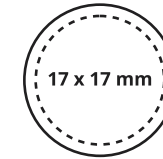

ADJUSTER FRONT



ADJUSTER BACK

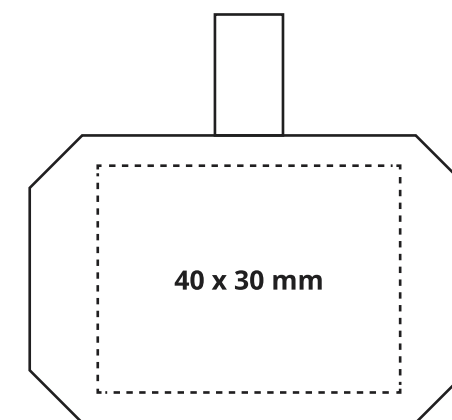

PATCH FRONT

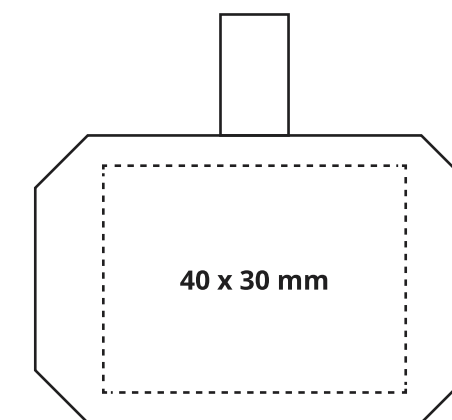

PATCH BACK

LEGEND:

----- SAFETY AREA

_____ FINISHED COMPONENT