













MPAPSI

COTTON APRON

Fabric: Cotton 100%
Grammage: 230 gsm
Item: 65 x 90 cm
Technique: Silkscreen
Embroidery

COTTON - STANDARD COLOURS

	WHITE		627 C
	BLACK		447 U
	207 C		2310 U
	136 C		2312 U
	1505 C		COOL GRAY 8 C
	2121 U		404 U
	7685 C		WARM GRAY 10 C
	7686 C		7540 C
	REFLEX BLUE U		405 C
	534 C		510 C
	7546 C		7428 C
	5395 C		329 C
	PROCESS BLUE C		

SCALE 1:1

SCALE 1:1

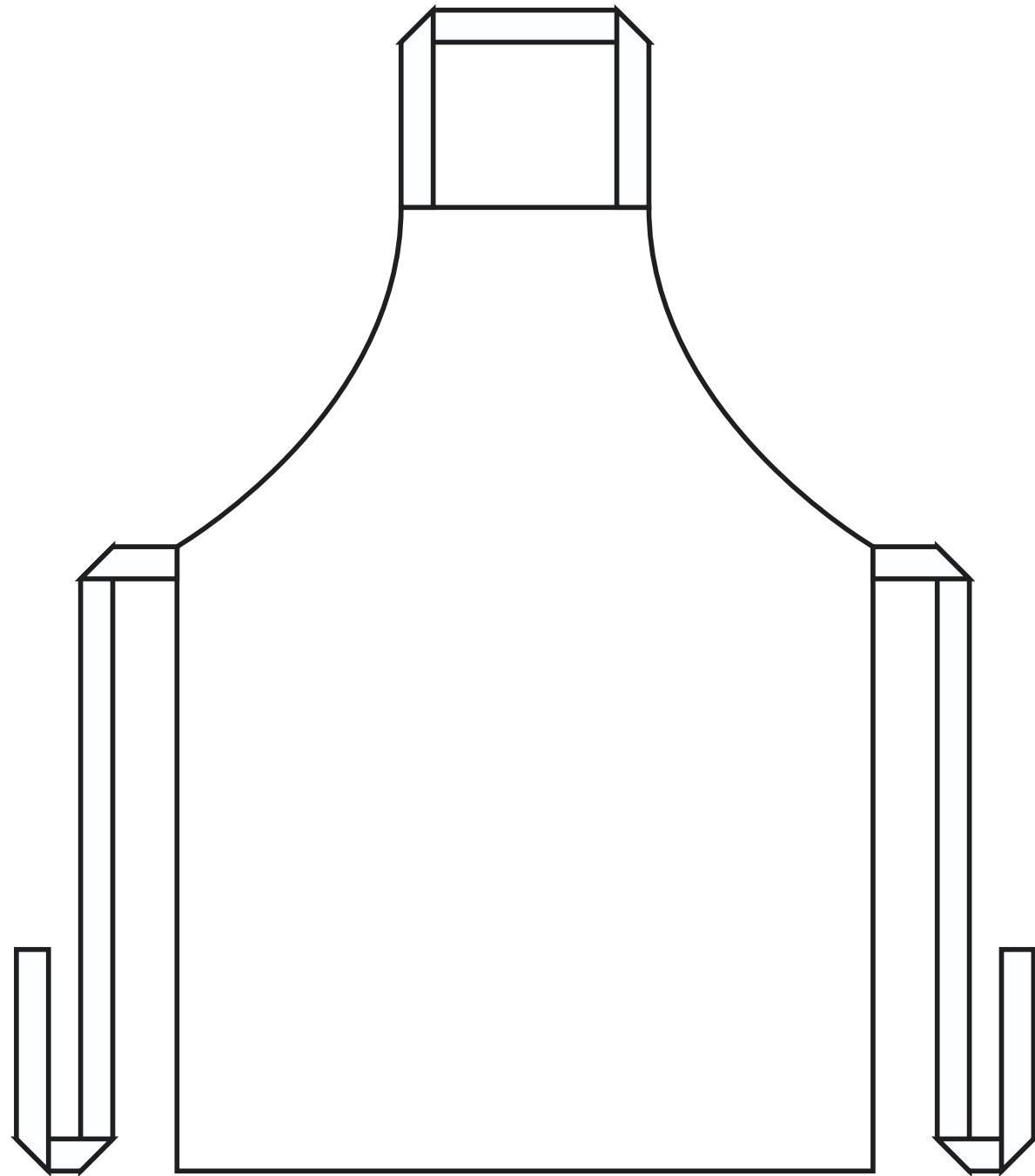

FRONT